



CSDR Industry Expert Group

Meeting # 2

Agenda Items

Timeline

Penalties Mechanism

- Calculation (T2S, CSD out)
- Issuer CSD / Security Maintaining Entity
- Daily Reporting

CSDR timeline

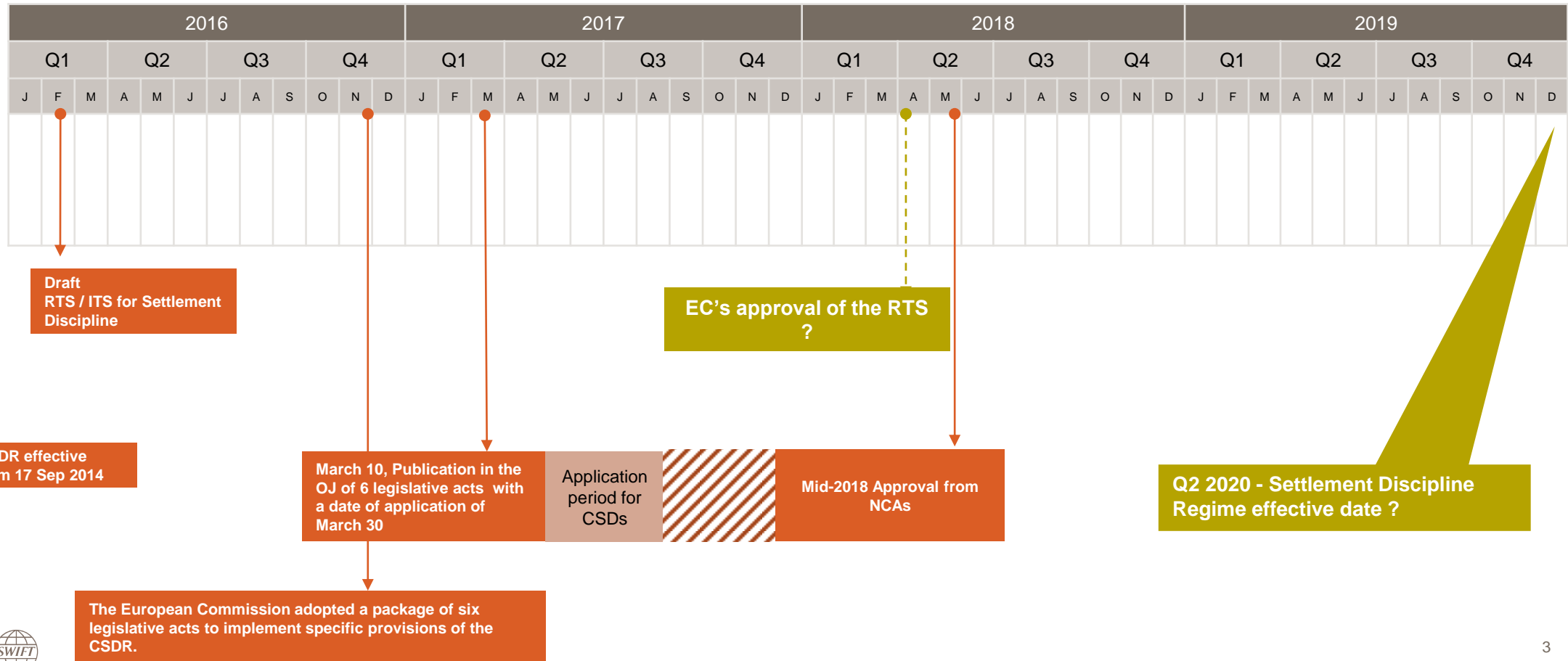

Actors

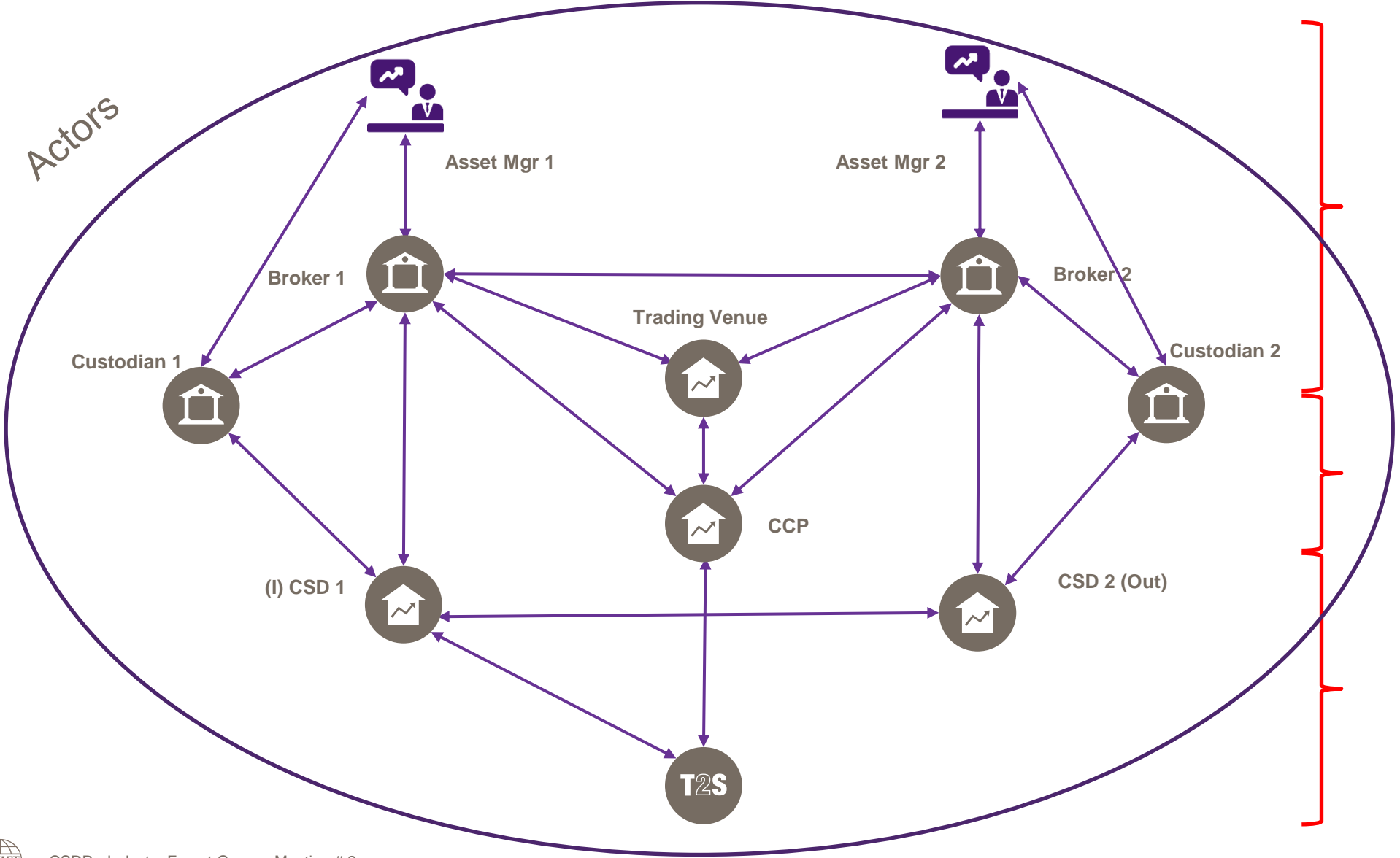

Trade

CCP Clear

Settle



CSDR Reporting

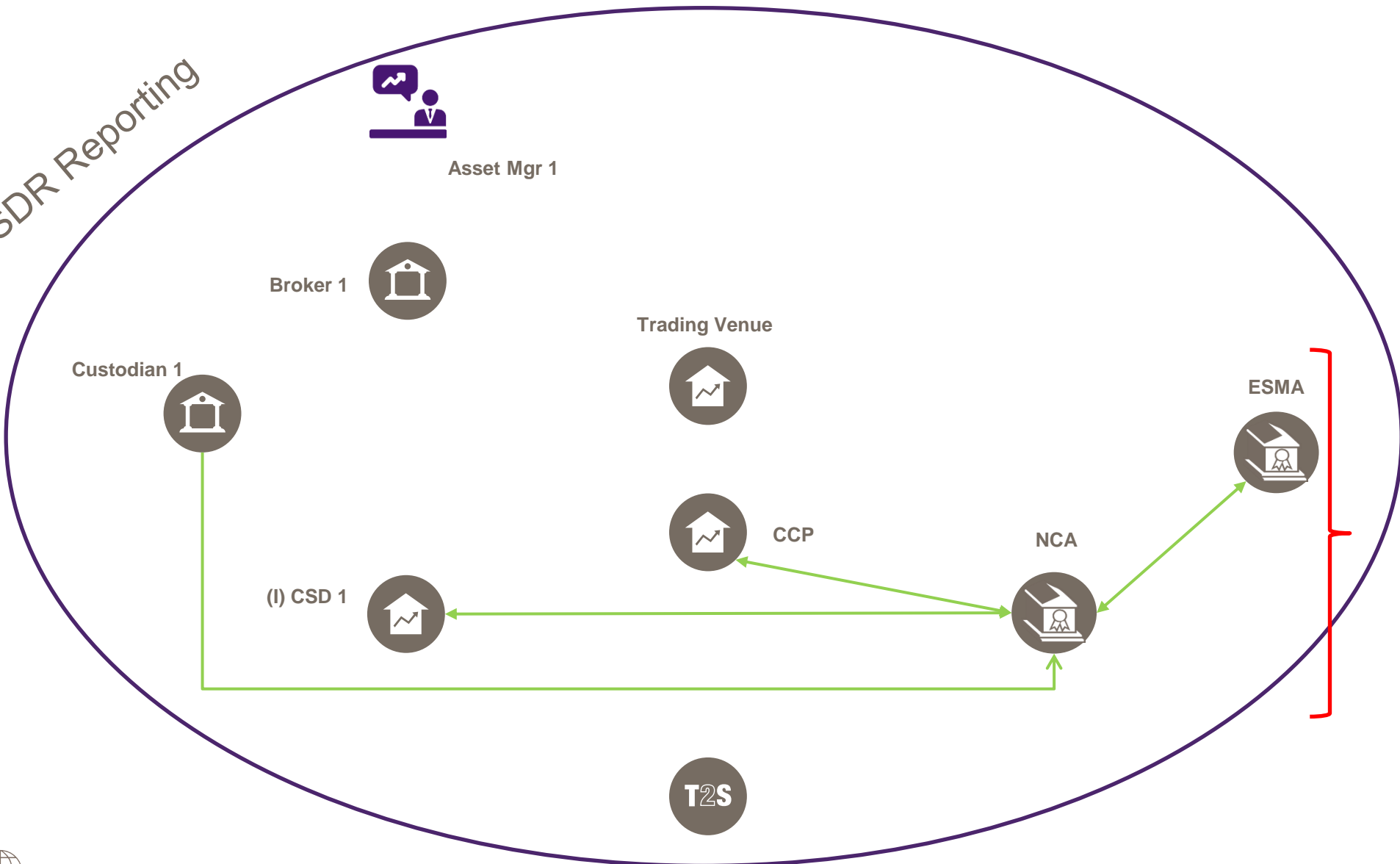

Late Matching and Settlement Fail Penalties

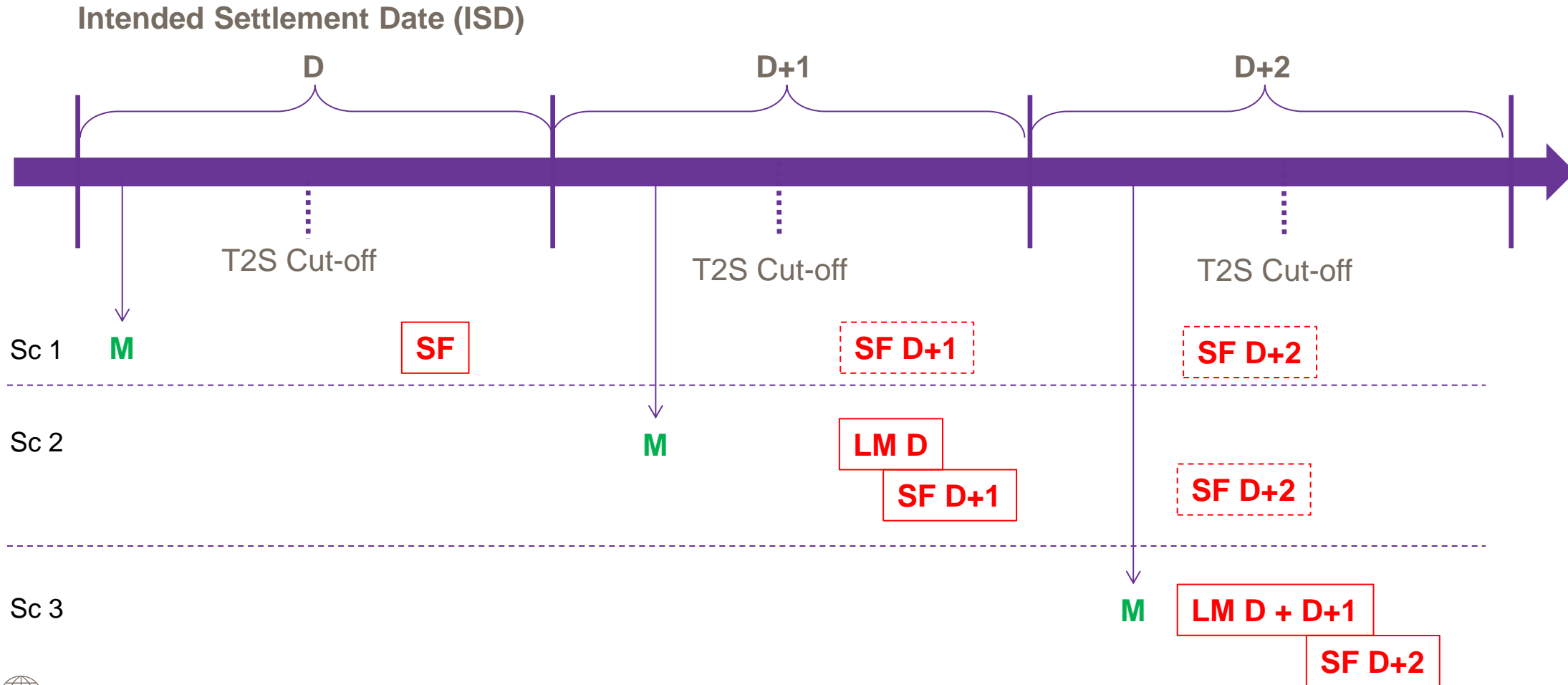

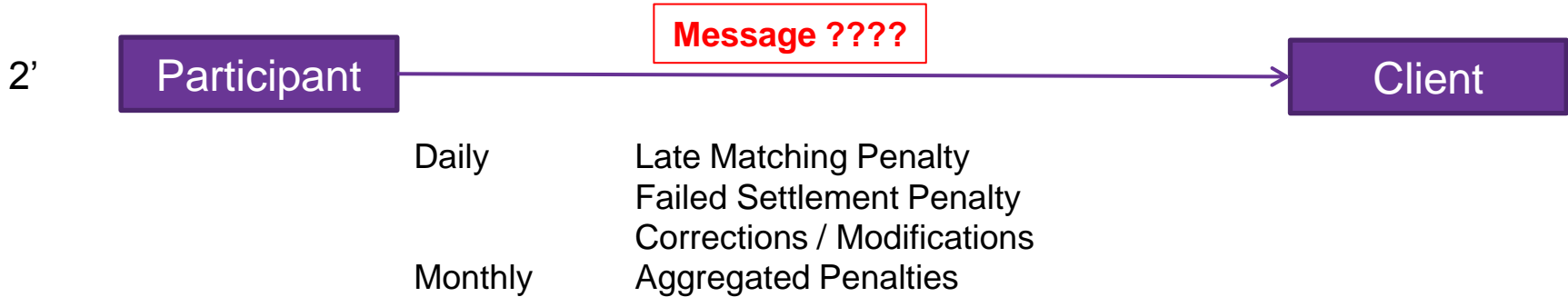
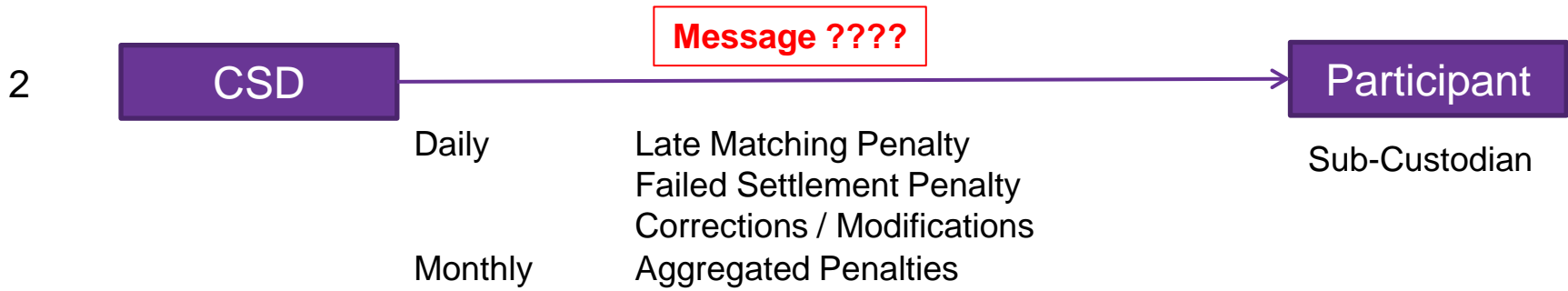
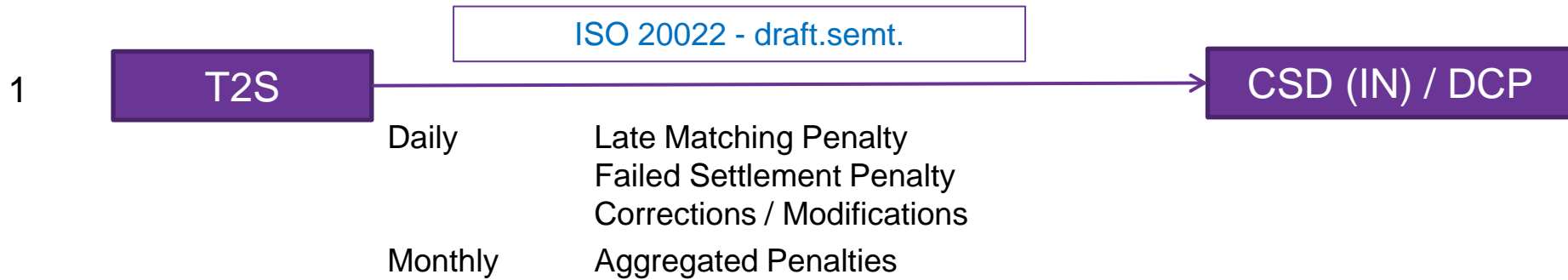

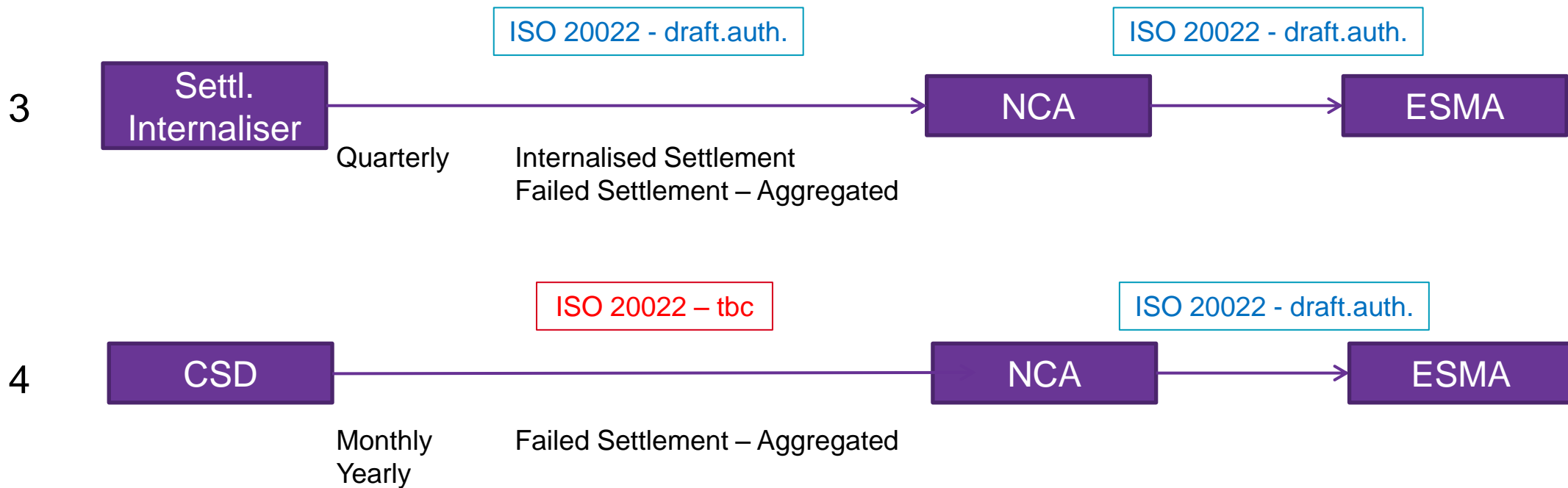

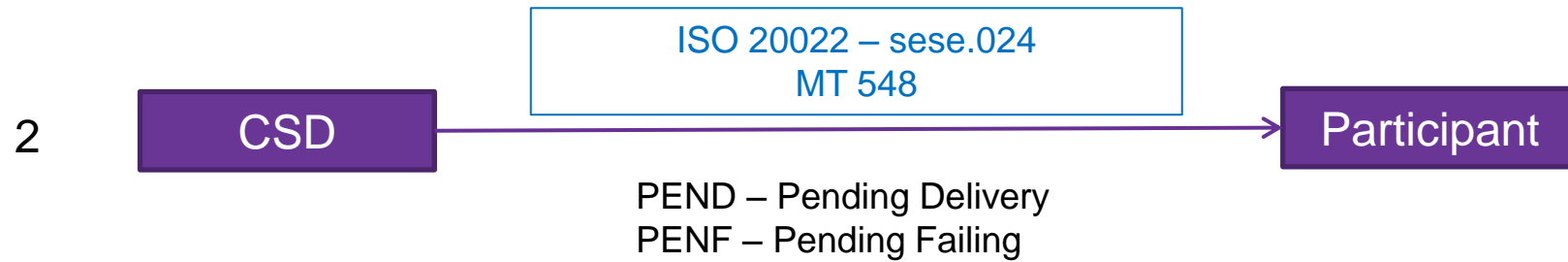
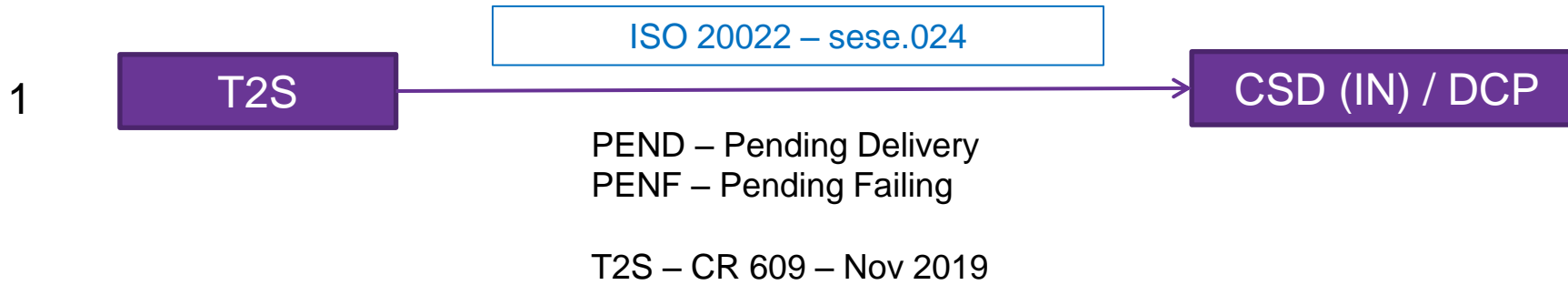



www.swift.com